

DRAGANFLY
INNOVATIONS INC

INVENTING THE FUTURE OF RADIO CONTROLLED FLIGHT



DRAGANFLYER* *IV* *Ti

CAUTION: ELECTRICALLY OPERATED PRODUCT:

NOT RECOMMENDED FOR CHILDREN UNDER 14 YEARS OF AGE.
AS WITH ALL ELECTRONIC PRODUCTS, PRECAUTIONS SHOULD
BE OBSERVED DURING HANDLING AND USE TO PREVENT
ELECTRIC SHOCK.

IMPORTANT

BEFORE ATTEMPTING TO OPERATE THIS FLYING DEVICE, ALL
PILOTS MUST CAREFULLY READ AND UNDERSTAND INSTRUCTIONS

DRAGANFLYER *IV* *Ti*

Warning!

THE Draganflyer V Ti IS NOT A TOY. IT IS A FLYING MACHINE CAPABLE OF CAUSING PROPERTY DAMAGE AND BODILY HARM TO THE OPERATOR AND SPECTATORS IF NOT OPERATED RESPONSIBLY.

Helicopters, by their nature, are not positively stable. Even if assembled and adjusted properly, the Draganflyer V Ti will not hold a particular position without constant corrections from the operator, and will not automatically recover from an unwanted attitude without intervention.

High capacity rechargeable batteries such as the Lithium-Polymer flight batteries used by the Draganflyer V Ti are capable of causing a fire if not treated correctly. Proper handling techniques and precautions must be taken in order to avoid creating a hazardous situation. **READ AND UNDERSTAND THE BATTERY SAFETY INFORMATION CONTAINED WITHIN THIS MANUAL BEFORE YOU ATTEMPT TO CHARGE OR USE THE SUPPLIED BATTERIES.**

WARNING! THIS PRODUCT CONTAINS CHEMICALS WHICH ARE KNOWN BY THE STATE OF CALIFORNIA TO CAUSE CANCER, BIRTH DEFECTS AND/OR OTHER REPRODUCTIVE HARM. Many common materials, such as metals, plastics, glues, lubricants and coatings contain chemicals in varying amounts and concentrations which will cause harm if introduced into the human body. For further information on toxic or dangerous chemicals, please refer to California's health and safety codes sections 25249.5-13.

Table of Contents

Warnings	2
Safety Information	3
Component List.....	4
Introduction.....	4
Detailed Components	5, 6
Assembly	6 - 8
Familiarization.....	9 - 10
Transmitter	11
Flight Controls.....	11 - 12
Battery Safety	13
Charging Transmitter and Lithium-Polymer Batteries	14
Thermal Intelligence	15
How the Draganflyer Flies	16 - 18, 21 - 22
Assembly Diagram	18, 19
Flight Training, Trimming and Maintenance	23 - 31
Optional Eyecam Wireless Video	32 - 34
Troubleshooting.....	35 - 36
Accessories and Replacement Parts	37
Notes	38

Important Safety Information

- ALWAYS WEAR APPROPRIATE EYE PROTECTION WHEN OPERATING THE Draganflyer V Ti. Loose parts or airborne debris ejected from the Draganflyer V Ti could cause serious injury to the human eye.
- This flying machine is designed for use by people over 14 years of age.
- **This instruction manual contains important information and must be kept.**
- Do not fly in dangerous situations, including areas where electrical hanging wire exists or in stairwells.
- Only use the Lithium-Polymer battery supplied with this kit; use of other batteries could damage the Draganflyer V Ti or the batteries.
- Unplug the Lithium-Polymer battery pack when not in use.
- **Never charge batteries unattended.**
- The Draganflyer V Ti must not be used if any damage has occurred to the electronics, blades, or frame.
- Do not expose the Draganflyer V Ti to rain or other liquids.
- Do not fly outdoors if it is raining, snowing, or extremely windy.
- Keep face, eyes, fingers, clothing, etc. clear from propellers.
- Do not attempt to lift objects with the Draganflyer V Ti.
- The Draganflyer V Ti is a precision machine and is vulnerable to misuse and abuse. Protecting all components is an essential part of maintenance.
- Only use spare parts recommended or supplied by Draganfly Innovations.
- Do not fly over or near bodies of water.
- Do not fly without the canopy installed.
- **NEVER FLY OVER OR NEAR PEOPLE.** Always keep your Draganflyer V Ti a safe distance from yourself and others.
- Periodically check the tightness of all bolts, nuts, and screws. Loose parts could cause the Draganflyer V Ti to crash.
- Replace broken or worn components with original parts only. It is important to locate and understand the cause of failure (including pilot error) to avoid recurring problems.
- Never modify any part of the rotor system or drive train. Modification could lead to component failure.
- Keep your Draganflyer V Ti, radio, and related equipment clean and in good repair. Regular cleaning and maintenance can find and fix potential problems (such as loose or damaged parts) before they occur.

Check for hidden damage after a crash. Damaged components could fail spontaneously in flight causing more serious damage.

Component List

Quantity	Description
1	Draganflyer V Ti Circuit Board
1	Draganflyer V Ti Carbon Fiber Frame
1	Carbon Fiber Base Plate
1	Clear Dome Canopy
1	4-Channel Digital Proportional FM Transmitter
1	3-cell 11.1 volt Lithium-Polymer battery.
1	Set of 4 rotors (2 Clockwise and 2 Counter-Clockwise) and Decal Sheet
1	120-volt AC peak charger for Lithium-Polymer battery pack and transmitter
1	Set of Velcro tape for flight battery

Draganflyer V Ti Small Parts Pack for main frame including:

1	5/64" Allen key wrench
4	6/32 Nylon Nut Caps for Carbon Fiber Bottom Plate
12	2-56 x 3/8" Hex Socket cap Bolt for main frame bolts
12	#2-56 3/16" x 1/16" Hexagon Nuts for main frame
8	#4-40 x 3/8" nylon mounting screws for main rotors
1	Instruction Manual(you are holding this now!)
1	Instructional DVD or VHS tape(NTSC only)

2.4 GHz Wireless Colour Video System (optional)

1	Colour Micro Video Camera with transmitter
1	Receiver
1	AC Adapter for Camera
1	AC Adapter for Receiver/Down converter
1	Battery Case
1	A/V Cable

Introduction

Congratulations on your purchase of a Draganflyer V Ti! We believe it to be the most innovative flying machine available on the radio control market. Please be sure to read the appropriate sections of this manual thoroughly before you attempt to assemble or fly your Draganflyer V Ti.

The Draganflyer V Ti flies similarly to a radio controlled helicopter. If you are a model helicopter pilot, you should be up and flying within a few minutes. If you are not familiar with helicopters or are new to R/C, DON'T PANIC. The Draganflyer V Ti is actually much easier to fly than a traditional helicopter because of the advanced Thermal Intelligence technology. This allows the Draganflyer V Ti to self-correct when flying outdoors. It is our experience that new pilots tend to over control the helicopter or just the opposite, they do nothing at all. This is where the Thermal Intelligence lives; if you get disoriented you can simply allow the Draganflyer to automatically regain stability. However, please be aware that the gyros and thermal sensors will not fly the Draganflyer for you, they only provide stabilization. To read more about how this amazing flying machine works, please read the section "How the Draganflyer Flies".

Detailed Components Draganflyer V Ti

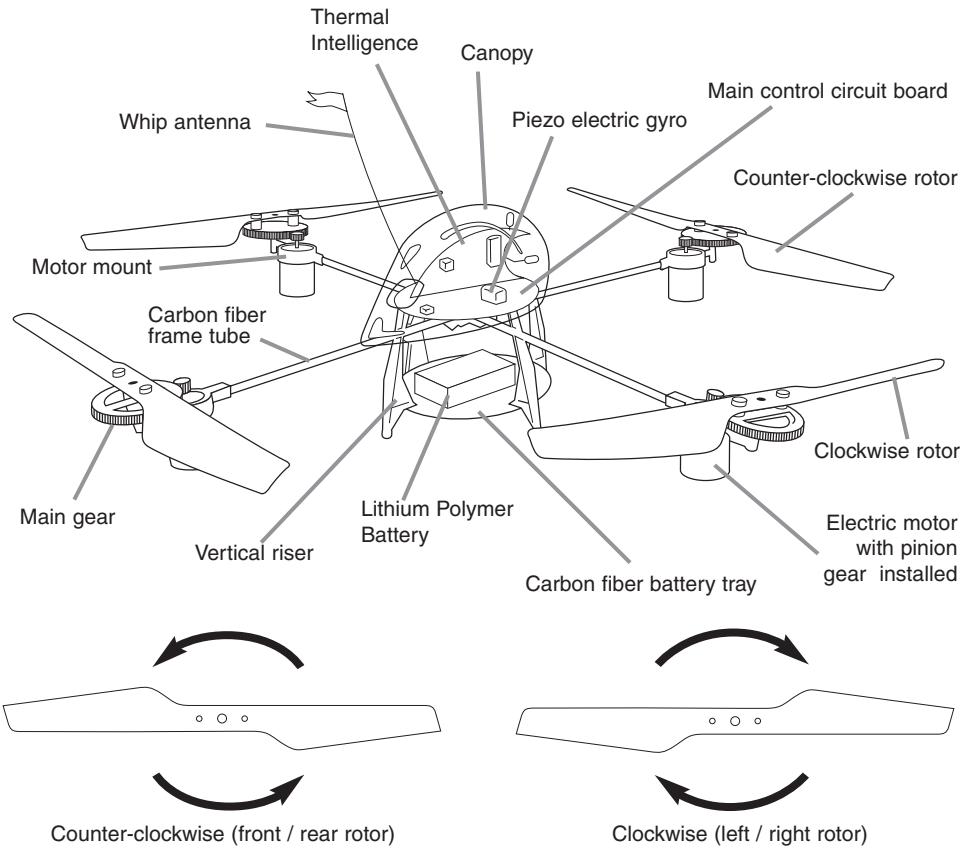

Detailed Components Charger

3 Cell Yellow Lithium Polymer Charger

Lithium Polymer Connector (1300mA output)

Transmitter Connector (50mA output)

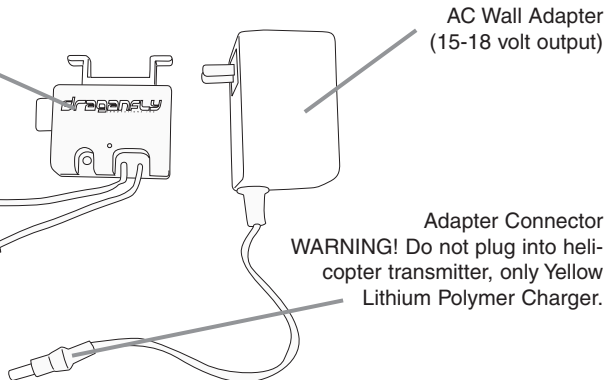

Detailed Components Transmitter

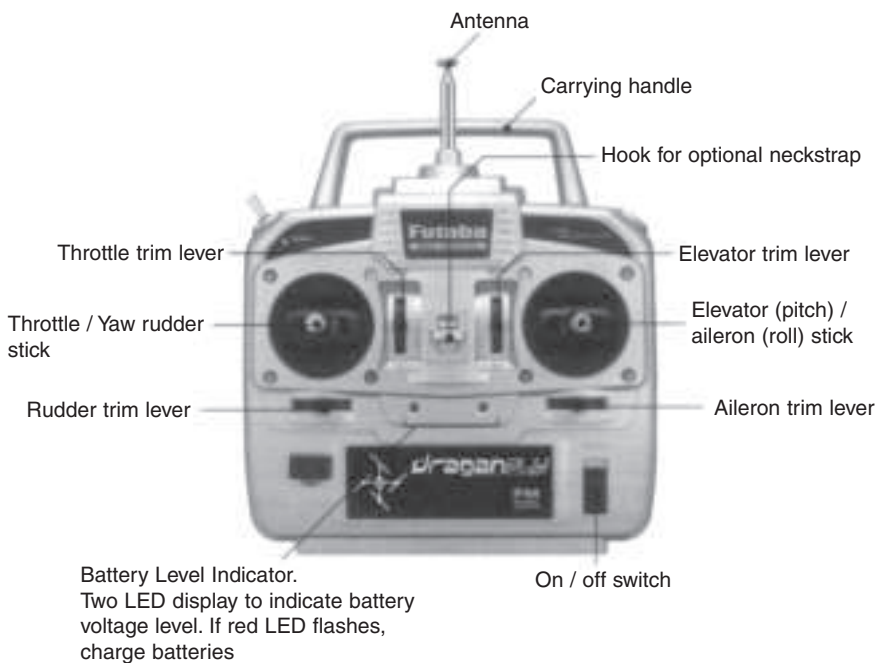

Draganflyer V Ti Assembly

Many of the steps involved in assembling the Draganflyer V Ti have already been performed in our factory. Every Draganflyer V Ti's circuit board has been test flown by experienced pilots. While assembling the Draganflyer V Ti, you can also refer to our instructional video and assembly schematic on Pages 16 & 17.



- 1) Charge the transmitter and the Draganflyer V Ti battery while you are building your Draganflyer V-Ti so that they are fully charged for the testing part of the assembly. Refer to the charging instructions on Page 13.
- 2) Unpack and verify that you have all parts against the components list on Page 4.

Draganfly V Ti Assembly continued

- 3) Lay out the frame. The front motor arm will already be inserted into the cross section. The front vertical riser will also have a colored dot on it. Do not remove this until after assembly. *See photo 7-A*
- 4) Insert the remaining 3 frame arms into the cross section, ensuring that all frame arms are securely pushed into the cross section. Note: It may be necessary to pull the wires at the cross section to take up any slack as the frame arms are inserted into place. *See photo 7-A*
- 5) Screw four 2-56 x 3/8" hex socket cap bolts into the cross section, attach nuts and tighten frame arms in place using the supplied 5/64" Allen key wrench. Note: Do not over-tighten as you will distort the plastic pieces. The nuts recess into the larger opening of the hole. *See photo 7-B*
- 6) Tighten motor mounts using 2-56 x 3/8" allen bolts and nuts. Ensure that the motors are straight up and down and pushed all the way into the mount. *See photo 7-C*
- 7) Hold the circuit board over the cross section and insert the main wire harness plug into the large connector on the circuit board. **Orient the circuit board's LED eyeballs towards the front motor.** The front is marked by the red dot on the vertical riser. If you are still unsure as to which motor is the front, it has one red and one black wire attached to it. Note: Be sure the opening of the center area of the cross section is facing upward with the harness protruding straight up. *See photo 7-D*
- 8) Slide the vertical risers towards the circuit board until they capture the edge of the circuit board at the notches on the circuit board and tighten the vertical riser using (4) 2-56 x 3/8" Hex Socket bolts and nuts. *See photo 7-E*

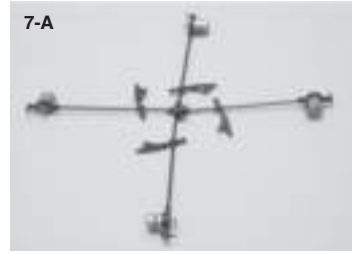

Draganflyer V Ti Assembly continued

- 9) Attach the carbon fiber battery tray to the bottom of the vertical risers' nubs using the four 6/32 Nylon Acorn Nut Caps. *See photo 8-A*
- 10) Attach decals to the top surface of the blades, making sure that the unique color decal goes on the front blade. The front blade will be one of the 2 counter-clockwise blades. *See photo 8-B*
- 11) Install Velcro tape on the battery tray between the front and rear vertical risers. Install the opposite side of Velcro on the battery pack, making sure to put it on the flat side opposite of the battery wire. *See photo 8-C*
- 12) Attach the canopy front first by inserting the vertical risers' nubs into the 3 holes on the side of the canopy. Note: The rear of canopy is not supported by the rear vertical risers nub. *See photo 8-D*
- 13) Attach the rotors to the black main gears using two #4-40 x 3/8" nylon mounting screws per rotor. Do not over-tighten. The front and rear blades are designed to turn counter-clockwise (front blade has the unique color decal). The left and right blades are designed to turn clockwise. Note: The front and rear blades are shaped identically and the left and right blades are shaped identically. *See photo 8-E*
- 14) Congratulations! You are now ready to set the parts in motion. Refer to Draganflyer V Ti Familiarization. Enjoy your completed Draganflyer V Ti!



Draganflyer V Ti Familiarization

Never fly this aircraft where damage to property or injury to persons may result if loss of control occurs. Never leave the Draganflyer V Ti unattended with the battery connected to it. Always disconnect the battery when not flying. Always turn the Draganflyer V Ti off before turning off the transmitter. Failure to do so could cause the Draganflyer V Ti to become airborne and out of control resulting in injury or damage. We cannot stress this enough! Always be sure to either enable or disable the thermal intelligence before each flight. Thermal intelligence should only be enabled for outdoor use

Start-up Procedure (thermal intelligence disabled)

- 1) Turn the black on-off switch on the circuit board to the off position. *See photo 9-B*
- 2) Install the battery and connect it to the circuitboard. We recommend placing one finger on the circuit board to brace it when connecting to the terminals. To release the battery, press the hinged connector to unclip from the circuit board.
- 3) Make sure the throttle is at the lowest position before turning on the transmitter. Center all of the trim levers on the transmitter. Turn the transmitter on and fully extent the antenna. The transmitter **must** be turned on before you turn the Draganflyer V Ti on, **this is very important!** *See photo 9-A*
- 4) Insure the transmitter is properly charged. If the red LED on the transmitter flashes or is not lit the transmitter must be recharged.
- 5) Turn the switch on the Draganflyer V Ti to the ON position. You will note that the red LED will start blinking. Make sure at this stage that when you advance the throttle stick, the red LED blinks faster. This verifies the functionality of the radio link. Return the throttle to the lowest position.
- 6) For safety reasons hold the Draganflyer V Ti down on the ground by the canopy. Hold the left control stick full left and down while you push the arming button. This both arms the helicopter and disables the thermal intelligence. Always be prepared for the motors to turn on! If they come on and you cannot throttle them back, turn off the switch on the circuit board and refer to the Troubleshooting section. *See photo 9-C*
- 7) Turn the Draganflyer V Ti and transmitter off, and disconnect the flight battery. Refer to the Flight Training section so you can begin learning how to fly your Draganflyer V Ti

9-A



9-B

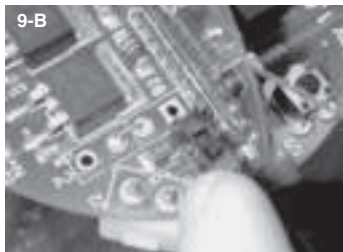

9-C



Draganflier V Ti Familiarization continued

Never fly this aircraft where damage to property or injury to persons may result if loss of control occurs. Never leave the Draganflier V Ti unattended with the battery connected to it. Always disconnect the battery when not flying. Always turn the Draganflier V Ti off before turning off the transmitter. Failure to do so could cause the Draganflier V Ti to become airborne and out of control resulting in injury or damage. We cannot stress this enough! Always be sure to either enable or disable the thermal intelligence before each flight. Thermal intelligence should only be enabled for outdoor use

Start-up Procedure (thermal intelligence enabled)

- 1) Follow the steps 1 thru 5 on previous page.
- 2) Each time you fly the Draganflier V Ti with the thermal intelligence enable, you must first teach the sensors the difference between sky and ground. While outside hold the Draganflier V Ti by the baseplate, positioning the led 'eyes' straight up and away from yourself. Before arming look at the green eyes, one of three things will occur. (Always hold the Draganflier a safe distance from your face and eyes.)
 - If both eyes are lit, the Draganflier is receiving a strong reading between the earth and the sky. Automatic levelling will work well.
 - If only one eye is lit, the difference between sky and earth is blurry. Automatic levelling will work but the Draganflier may not be as stable.
 - If neither of the eyes are lit, conditions are not suitable for automatic levelling and you should either turn this feature off (see below) or fly when conditions are improved.
- 3) To calibrate simply press the arming button while the led 'eyes' are point up. Be sure to hold the Draganflier by the baseplate so the sensors do not get confused by your body heat. *See photo 10-A*
- 4) To disable this feature hold the left stick down and to the left while you push the arming button
- 5) To improve the accuracy of self-leveling, teach the Draganflier where level is by placing the Draganflier on a level surface. Stand back 10-15 feet and hold the left stick full down and right. The red light on top will blink to confirm that the level position has been saved. This must be reprogrammed if there is a drastic change in temperature or flying conditions.
- 6) Turn the Draganflier V Ti and transmitter off, and disconnect the flight battery. Refer to the Flight Training section so you can begin learning how to fly your Draganflier V Ti.

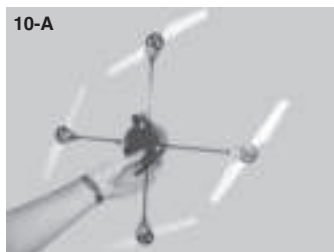

The Draganflier V Ti also includes an advanced automatic land feature in case of loss of signal from the transmitter. To program the Draganflier to use this feature, you must first fly the Draganflier and adjust the trims so that it is stable and has no tendency to drift in any direction. Land, and while holding the rudder full left, press the arming button on the Draganflier to save the trim settings. If the trim changes (such as after crash repairs), this feature must be reprogrammed to save the changes

The Draganflyer V Ti Transmitter & Radio

Precautions

Warning: If the radio system is turned on or off in the wrong order, the motors may go to full throttle unexpectedly and cause an injury or damage to property.

Prohibited

- Do not fly multiple Draganflyer V Ti's simultaneously on the same frequency. Interference will cause a crash.
- Do not fly outside on rainy days or at night.
- Do not fly in the following places:
 - Near people on the ground or objects in the air.
 - Near schools, hospitals or other places where there are a lot of people.
 - Near high tension lines, electrical substations, high structures or communication facilities.

Do not fly when you are tired, sick, or intoxicated. Fatigue, illness, or intoxication will cause a loss of concentration or normal judgement and result in input errors and a crash.

When placing the transmitter on the ground during flight preparations, make sure it cannot be knocked over.

Make sure you extend the transmitter antenna to its full length. If the antenna is too short, the effective range of the radio will become shorter and reception problems can occur.

When turning on the power, always set the throttle stick to the lowest position, and follow these steps in order.

- 1) Turn on the transmitter power switch.
- 2) Connect lithium battery
- 3) Turn on the Draganflyer V Ti power switch.

When turning off the power, always have the Draganflyer V Ti stopped and at the lowest throttle setting, and follow these steps in order.

- 1) Turn off the Draganflyer V Ti power switch.
- 2) Disconnect the Draganflyer V Ti flight battery
- 3) Turn off the transmitter power switch.

Flight Controls

Aileron Operation (Left/Right - Roll)

When the aileron stick is moved to the right, the Draganflyer V Ti will tilt to the right. The left motor speeds up and the right motor slows down. When the aileron stick is moved to the left, the Draganflyer V Ti will bank to the left. The right motor speeds up and the left motor slows down.

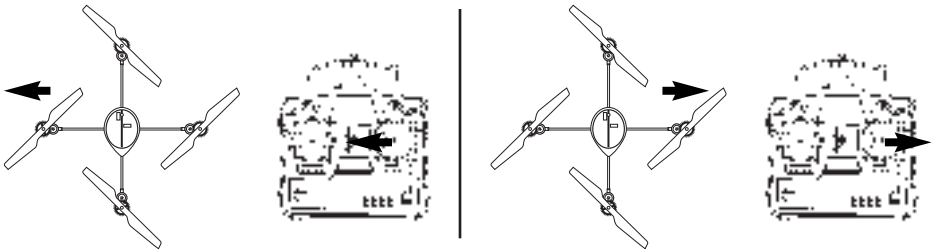

Flight Controls continued

Elevator Operation (Forwards/Backwards - Pitch)

When the elevator stick is pulled back, the Draganflyer V Ti will tilt in a backwards direction. The front motor speeds up and the rear motor slows down. When the elevator stick is pushed forward, the Draganflyer V Ti will move in a forward direction. The rear motor speeds up and the front motor slows down.

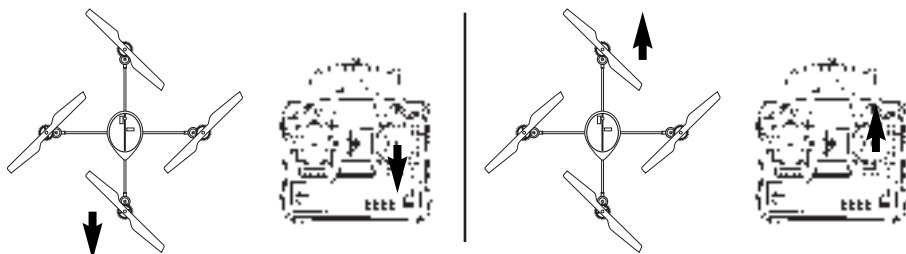

Throttle Operation (Power Control - Ascend/Descend)

When the throttle stick is pushed forward, all motors on the Draganflyer V Ti will increase in speed. When the throttle stick is pulled backward, all motors on the Draganflyer V Ti will decrease in speed. The Draganflyer V Ti will be in ground effect in the first twelve inches off the round. This generally requires less power and the Draganflyer V Ti is less stable.

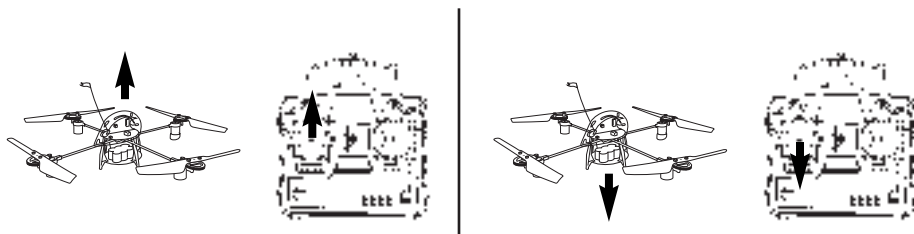

Rudder Operation (Rotating Clockwise/Counter-Clockwise - Yaw)

When the rudder stick is moved to the left, the clockwise turning rotors speed up while the counter-clockwise turning rotors slow down. This makes the Draganflyer V Ti rotate to the left. When the rudder stick is moved to the right, the counter-clockwise turning rotors speed up while the clockwise turning rotors slow down. This makes the Draganflyer V Ti rotate to the right.

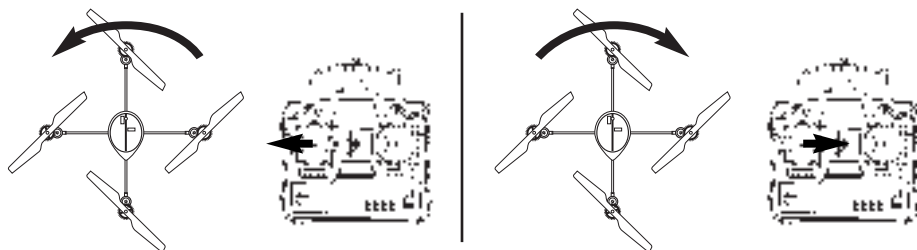

Battery Safety

Lithium-Polymer batteries are a revolution in battery technology. These next-generation batteries are capable of powering the Draganflyer in ways that would have been unimaginable only a year ago. However, Lithium-Polymer batteries require special consideration and handling techniques due to their extremely high capacity.

Use only chargers designed specifically for Lithium-Polymer batteries

Use only Draganflyer Lithium-Polymer batteries with your Draganflyer V Ti and charger

Never allow the battery to short circuit

Do not leave Lithium-Polymer batteries charging unattended

Do not charge batteries near flammable materials

Do not store Lithium-Polymer batteries inside of your vehicle. Temperatures inside a parked vehicle can rapidly exceed the recommended maximums.

Do not allow the battery temperature to exceed 160 degrees Fahrenheit. Permanent damage will result.

Do not allow the battery to discharge below 9 volts, this will permanently damage the battery.

After a serious crash, visually monitor the Lithium-Polymer battery for swelling or overheating on a fire-proof surface (ie, concrete) to ensure it has not sustained any internal damage.

If the Lithium-Polymer battery is damaged in a crash or appears to swell, discontinue use immediately, place the battery away from anything flammable (ie bare concrete floor), and contact Draganflyer Innovations technical support for assistance.

Flying with Lithium-Polymer Batteries

1. Read [Draganflyer V Ti Lithium-Polymer Battery Precautions](#) before charging or using batteries.
- 2) When the battery voltage begins to drop the helicopter enters a forced landing condition. All of the controls will be the same except the maximum allowable throttle will be slowly reduced. In this mode all of the led 'eyes' will blink together. Land and recharge the battery. Attempting to fly past this point will permanently damage the battery.
- 3) Allow the Draganflyer V Ti motors to cool after every 6-9 minutes of flight. Extended continuous operation of the Draganflyer V Ti (especially when performing advanced maneuvers) will result in overheating of the motors and possibly shorten their life. This will also allow the battery to cool, resulting in longer flight times and longer overall life for the batteries.
- 4) Allow the battery to cool to room temperature after use and before charging as well as after charge and before use in the Draganflyer V Ti.
- 5) If you notice a performance decrease of greater than 20% in your Lithium-Polymer battery, the battery is at the end of its life cycle. Do not continue to use, and ensure the battery is disposed of properly. Repeated continuous operation of the Draganflyer V Ti without allowing appropriate time for the motors to cool will result in premature wear and shortened life for the motors.
Replacement motors are available.

Charging Draganflyer V Ti Batteries

The supplied charger is designed to quickly charge Lithium-Polymer batteries as well as charge your transmitter. It will fully charge the supplied lithium-polymer battery in approximately 1-2 hours. This charger operates only from the supplied AC wall transformer.

Operation:

1. Connect the AC adapter to the AC power source(wall plugin). Connect the charger input to the AC adapter. The green light will blink when power is applied to the charger with no battery connected.
2. Connect the charger output to the battery using the supplied cable.
3. When the green light goes out the battery is charged.
4. To charge another battery, make sure you disconnect the AC power for 10 seconds to reset the charger. Reconnect the AC power then connect battery.

To charge the transmitter, connect the barrel adapter on the charger to the charge socket located on the side of the transmitter. The amber light will illuminate while the transmitter is charging. It will not extinguish when the transmitter is charged. The transmitter will take 14-16 hours to charge fully.

Note: The Transmitter and the Lithium-Polymer packs can be charged simultaneously

Note: The charger and the battery pack may get warm when charging. Disconnect the AC adapter from AC power when the charger is not in use.

Caution: Too much heat can damage battery packs. Wait for the batteries to cool after flying before charging, and 15 minutes after charging before flying. It is advisable to have extra flight batteries so you can always be flying!

WARNING:

Do not leave the transmitter on charge for extended time (ie weeks); the internal NiCad battery may be damaged.

Do not leave charging batteries unattended.

Do not charge batteries near flammable materials.

If battery becomes hot, disconnect it immediately.

Charging Draganflyer V Ti Batteries



How does Thermal Intelligence work?

Thermal Intelligence (Ti) uses patented technology to sense the difference in infrared temperature between the Earth and sky. The sky is always at a relatively lower infrared temperature, while the infrared signature of the Earth is always relatively warmer. Ti uses four infrared sensors, so when a change is detected in the Draganflyer's orientation relative to the earth's infrared horizon, it issues the correct control signals to bring the Draganflyer back to level flight.

When the Draganflyer is flying above the Earth (even a few feet), the sensors see all the way to the earth's infrared horizon. The infrared temperature seen for the Earth is an average of infrared generated from all terrain features. Ti incorporates a microcomputer to interpret input from the sensors and modify signals between the aircraft's receiver and the motors controlling roll and pitch. This amazing technology is not adversely affected by clouds or snow, and works just as well at night. Calibration before each flight is utilized to ensure very accurate leveling over any terrain.

The Draganflyer V Ti also includes an advanced automatic land feature in case of loss of signal from the transmitter. To program the Draganflyer to use this feature, you must first fly the Draganflyer and adjust the trims so that it is stable and has no tendency to drift in any direction. Land, and while holding the rudder full left, press the arming button on the Draganflyer to save the trim settings. **If the trim changes(such as after crash repairs), this feature must be reprogrammed to save the changes in trim.**



Flying with Self Leveling

Flying the Draganflyer with the Self Leveling feature enabled is extremely easy. If you get disoriented or otherwise lose control, simply center the pitch, roll, and yaw controls, and reduce(or increase) the throttle to a point where the Draganflyer is hovering. The Self Leveling will automatically bring the Draganflyer back to a level and stable position. You may now either take back control, or land by simply slowly reducing the throttle. If the Draganflyer acts erratic or appears to be hunting for a level position, this may be a sign that the calibration process was unsuccessful. Turn off the Draganflyer and reattempt calibration. If it still acts erratic, disable the Self Leveling feature and if the problem persists, refer to the Troubleshooting section in the Draganflyer manual.

When the battery begins to get low, the Draganflyer will slowly reduce the maximum allowable throttle over a 10 second time frame. This is intended to allow a smooth descent before the batteries are completely empty. If you notice this occurring, allow the Draganflyer to land and recharge the batteries before you fly again. Taking off with batteries that are almost empty may cause the Draganflyer to act erratically.

The Draganflyer 5SL also includes an advanced automatic land feature in case of loss of signal from the transmitter. To program the Draganflyer to use this feature, you must first fly the Draganflyer and adjust the trims so that it is stable and has no tendency to drift in any direction. Land, and while holding the rudder full left, press the arming button on the Draganflyer to save the trim settings. If the trim changes(such as after crash repairs), this feature must be reprogrammed to save the changes in trim.

Please remember:

- Self Leveling does not compensate for wind
- Proper calibration is crucial for correct operation
- **Self Leveling does not work when flying indoors**
- Self Leveling cannot fly for you; You are responsible for maintaining control
- You are still required to trim the Draganflyer out , even with the Self Leveling feature enabled

Precautions

- Automatic landing is a fail-safe feature only! We do not recommend 'testing' this feature!
- Avoid flying near sources of heat, over asphalt, or large bodies of water. The temperature difference may confuse the self levelling feature and cause erratic flight.
- Self Leveling is designed for flight stabilization only. **It cannot fly for you!**
- Keep the 4 sensor windows on top clean using alcohol
- Perform an infrared calibration at the beginning of each flying session.
- You are still required to trim the Draganflyer out, even with the Self Leveling feature enabled
- **Always hold the Draganflyer a safe distance away from your face and eyes, and do not operate the Draganflyer in any way which endangers yourself or others!**

How the Draganflyer Flies

Written by Nick Sacco, Rotary Magazine

When I first saw the Draganflyer, I knew that this little electric, four-motor helicopter was pure fun. Even though I've flown conventional fuel-type helicopters for years, the idea of a four-motor, four-rotor helicopter was just too good to be true.

Although the Draganflyer is constantly undergoing engineering changes to make it more commercially desirable, its basic premise is that it is a stable hovering platform that climbs and turns by manipulation of the motor-rotor speed only! The Draganflyer uses some fairly sophisticated electronic wizardry to maintain its stable hovering characteristics, but all this is totally transparent (and should be) to the user. After all, do we want to enjoy it or constantly be tweaking and tuning it?

The daily "non-maintenance" is where the similarities to conventional model helicopters stop. As an avid helicopter hobbyist, I enjoy the tuning and tweaking that is a normal part of helicopter life. But I get a vacation from it with the Draganflyer. The Draganflyer is designed to be nearly maintenance free, have a long service life and provide the owner with valuable flying time anytime it is required!

The kit is nearly assembled when received. Wiring consists of plugging a couple of connectors together and the assembly steps are essentially tightening a few screws. Set-up for flight readiness is just as easy also: Charge the batteries, align the motors and go have fun! Quite a contrast to conventional helicopters whose complex pitch mechanisms demand hours of tuning and specialized radio gear.

When you purchase the Draganflyer, you don't have those tasks and all the necessary radio gear is included. Actually the Draganflyer is a complete flying package. All that's missing is YOU.

So how does it work?

The Draganflyer, as I alluded to earlier is designed as an integrated flight package. The circuit board that lives in the center of the machine is the magic (and truly the heart) of the Draganflyer. That means that the remote control system, the stabilization system, and the power system are built into it. There's nothing else to purchase. Let's break down these three main components of the Draganflyer and see just what makes it go...

The Remote Control

The remote control system consists of a 4-channel conventional FM system common in the remote control hobby industry. The Draganflyer uses a standard Futaba® radio transmitter, but in living up to its integrated design, the radio receiver is literally built into the Draganflyer's electronic "brain". Viewing the circuit board from the side, the radio receiver would be the top portion to which are mounted the LED's (light emitting diodes) that serve as the Draganflyer's "ready" indicator and eerie-looking "eyes." The remote control system is a 4-channel receiver having the decoder circuit, the oscillator and RF crystal (which determines on which radio frequency it is operating). Also located on this particular circuit board is a long square component called a piezo gyro. I'll come back to that when I discuss the Stabilization Section.

How the Draganflyer Flies continued

The Power System

This set of components is located on the horizontal circuit board and is essentially a set of 4 speed controllers – one for each of the 4 motors. The most obvious components are the large square devices located near the rear of the circuit board called FET transistors. FET means Field Effect Transistors. These devices may be thought of as an electronic valve. There are 3 wires on each FET. Two of the wires supply voltage to its motor, while the third wire (the trigger) is how the “valve” is opened. Apply a small voltage, the valve opens a little and the motors start to turn. Apply a little more voltage, and the motor turns faster still. Now just imagine that the FET is responding to your raising and lowering of the throttle stick on the transmitter (via the radio receiver) and you now have a grasp of just how the speed control works.

The wizardry in my opinion is how, by applying certain aspects of physics, the Draganflyer is controlled. Let me give you an example. When something turns, in this case a propeller, a force is generated by the motor called “Torque”. The propeller wants to turn one way and the motor, the other way. I am referring to Newton’s law that states that a force in one direction will produce the same force in the opposite direction. Another force caused by uneven thrust of the propellers at differing attitudes, is known as “P factor.”

Conventional helicopters overcome these forces by using a tail rotor. As the main rotor blades are turning via the engine, the opposing force is trying to turn the helicopter’s body in the opposite direction. The tail rotor has a variable pitch mechanism that simply pushes more (or less as the case may be) air and produces more linear thrust that offsets the effect of torque and “P factor”. Without a tail rotor, a conventional helicopter’s body would spin out of control. To actually cause the helicopter’s body to turn (or pirouette) the pilot either increases tail rotor pitch or decreases tail rotor pitch depending upon which way the turn is to be initiated.

In the case of the Draganflyer, the exact same forces apply. The speed controller is designed to match the front and back, left and right motor-rotor speeds to be exactly the same. But the Draganflyer rotates the left and right motor-rotors in the opposite direction from the front and back motor-rotors. This, in effect neutralizes the torque and “P factor” allowing the Draganflyer to hover without spinning out of control.

So what happens when you push the right transmitter stick to the right or left as you would in a turn? Simple, this is called Roll. The Draganflyer’s electronic brain receives the signal through the remote control receiver. The signal received tells the motor controller to send more power to the left motor-rotor and simultaneously reduce the power to the right motor-rotor by the same amount. This causes the Draganflyer to maintain altitude (total thrust has not changed) but to tilt up on the left side and thus begin a right turn. The exact same thing happens, albeit in the opposite direction when the transmitter stick is pushed to the left.

When the right transmitter stick is pushed forward or backward for a Pitch control (either nose up or nose down) a similar series of commands are given to the front and rear motor-rotors. Lastly, when the left transmitter stick is pushed to the right or to the left, simulating “rudder” on a conventional helicopter, the Draganflyer’s electronic circuit responds by increasing (or decreasing) the front and back motor-rotors opposite from the left and right motor-rotors. This in effect upsets the torque and “P factor” balance of the aircraft and the machine begins to pirouette in response to whichever direction the left transmitter stick is pushed.

Kept in either left or right pirouette, the little machine can get a wicked pirouette going that will make your head spin just watching it!

Thermal Intelligence - Returns Draganflyer to level and maintains a hover until you tell it otherwise.

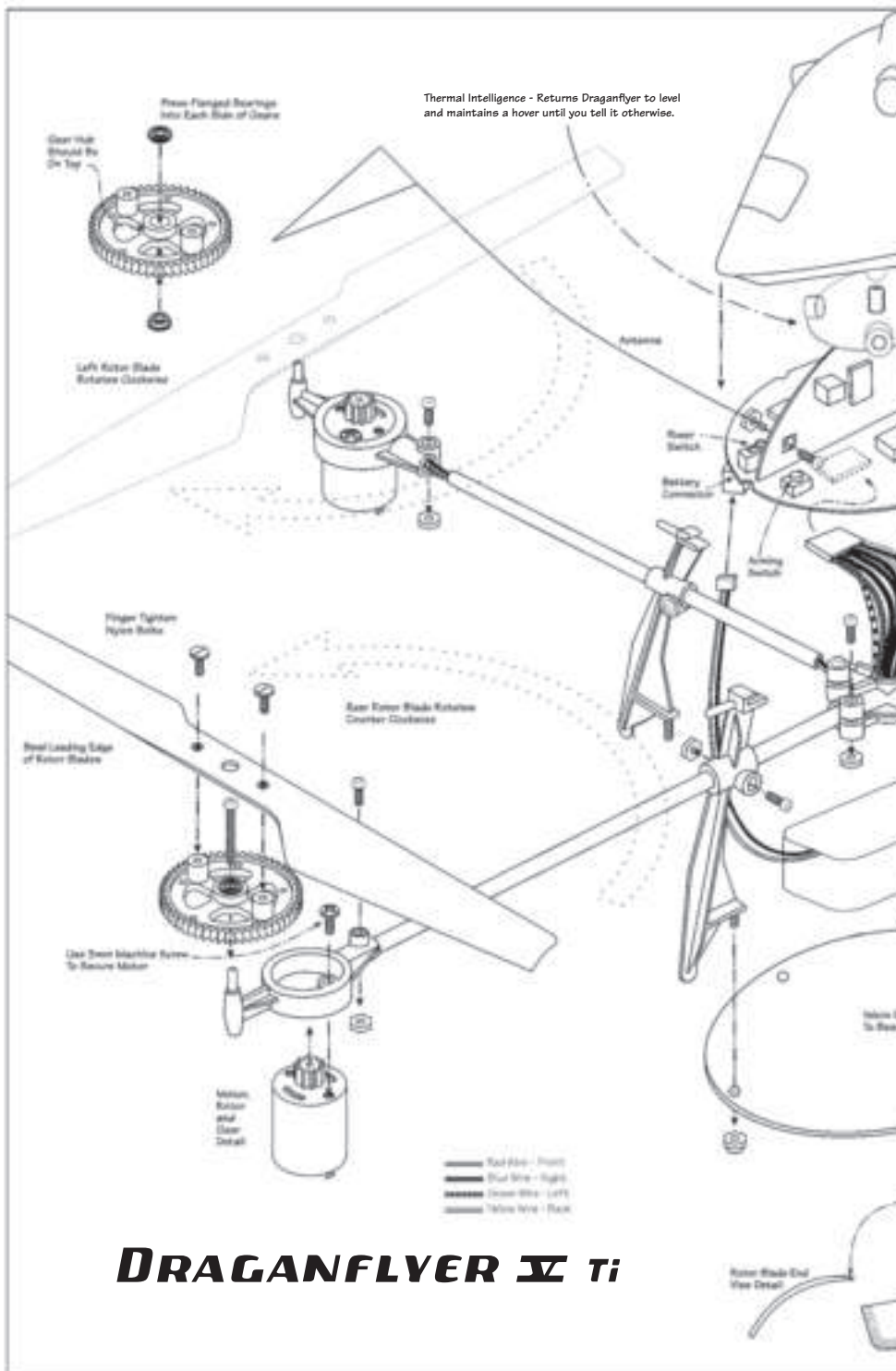

DRAGANFLYER Σ Ti

**** WARNING! ****

Circuit Board Must Be Located Correctly with Respect To Wire Colors or This Unit Will NOT Function Correctly!

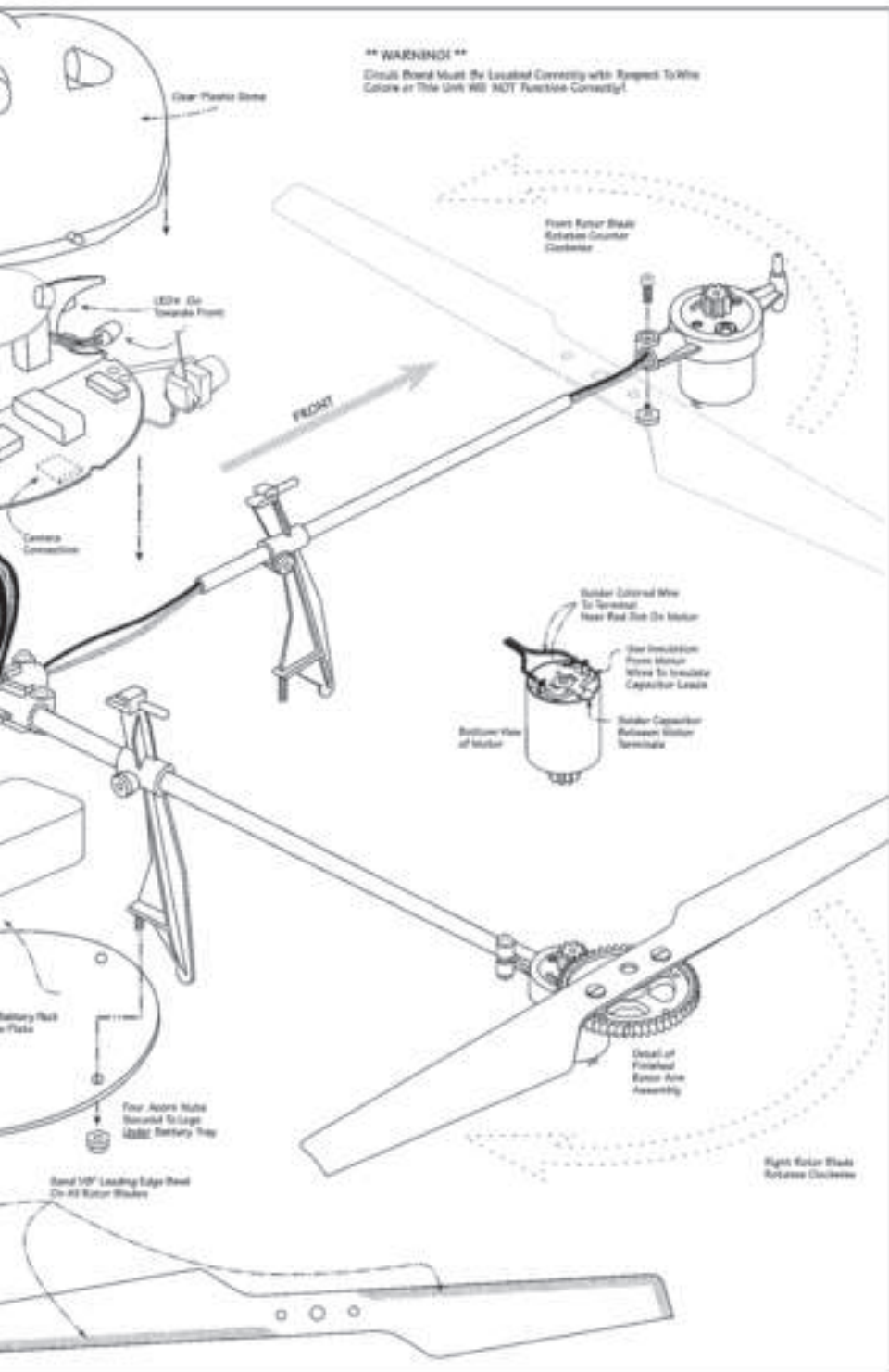

How the Draganflyer Flies continued

The Draganflyer has this speed logic built into the circuit board's "chips" and the ratio of motor-rotor speed is a design consideration of the machine.

The Stabilization System

Up to now, You've hopefully gotten a pretty good picture of just how the Draganflyer stays in the air and remains under control. What you may not appreciate, is that without the Stabilization System, no one could fly it! The Draganflyer's motor-rotors and propellers are designed to turn at a pre-determined RPM. Since nothing in this world is perfect, each motor is going to react to the same voltage differently and each FET is going to react to the "trigger" voltage differently. While these differences may be subtle, they are enough to make the Draganflyer nearly impossible to fly. So to create a usable machine, a stabilization system is employed. This same principle applies to many of the high-tech military aircraft such as the Stealth fighter.

In the case of the Draganflyer, the Stabilization System consists of some logic circuits and 3 of those long cylindrical devices called piezo gyros. As I said before, one is mounted vertically on the vertical circuit board, while the other two are mounted on the horizontal circuit board.

Of the two mounted on the horizontal circuit board, the left one is oriented in a front to back position, while the right one has a left to right orientation.

If you haven't guessed by now, they are mounted that way because of the 3-dimensional space that flight itself occupies. These piezo gyros are used to detect movement in 3-dimensional space. That is: Vertical and Horizontal or Up and Down flight as the receiver-mounted unit detects. Pitch (Pointing nose down or up) as the left horizontal-mounted gyro detects, and Roll as the right horizontal-mounted gyro detects.

Basically the piezo gyros are there to sense movement in any or all of 3-dimensional space and provide correctional motor control. Think of this as "dampening" the machine's controls. Without this dampening as I said previously, the machine would be nearly impossible to fly. This is simply due to the speed at which the machine's electronics are responding to the transmitter controls. Essentially, when we give a command to the Draganflyer, as in a turn for example, to the right the Piezo gyro circuit controls the speed at which the FET trigger responds and gives the motor-rotor speed changes. What we end up with is a well-behaved machine that is possible to fly!

Generally speaking, the piezo gyros are configured to produce the opposite effect to what they've sensed. That means that if the gyro senses the right side of the Draganflyer for example dropping, it increases power to the right motor and decreases power to the left to compensate. All this is programmed to happen for you. Of course to perform a right turn, the electronic brain understands that the stick commands from the transmitter override the built-in logic.

So how do the piezo gyros work? Piezo gyros actually harness 2 theories of Physics. One is the piezoelectric effect and the other is the Coriolis effect.

How many of us have used the familiar outdoor gas grill? If yours has that little red pushbutton that makes a snapping sound to produce a spark to ignite the gas, you've seen one example of the piezoelectric effect.

How the Draganflyer Flies continued

Pierre Curie discovered the piezoelectric effect in 1883. He noted that certain materials, such as quartz crystals, produce a voltage when they are mechanically stressed. Conversely, those materials' shapes are deformed when a voltage is applied to them. Piezo may be made of a several substances, but the most common are quartz, Rochelle Salt and barium titanate. Piezo derives its name from Greek. Piezein, to press tight, squeeze.

Essentially, when a force is applied (i.e., a hammer such as our gas grill example) a voltage is generated. Additionally, when a voltage is applied to piezo, it responds by bending. How much bend is determined by voltage and the structure itself.

How does this make a Draganflyer more stable? Again, we turn to the other basic theory of Physics I mentioned - The Coriolis Effect. Some people have heard of this while watching the weather channel. The Coriolis Effect was named for Gaspard-Gustave de Coriolis was born in June 1792 to Jean-Baptiste-Elzéar Coriolis and his mother Marie-Sophie de Maillet. Coriolis is best remembered for naming and demonstrating that the laws of motion could be used in a rotating frame of reference if an extra force called the Coriolis acceleration is added to the equations of motion.

What does that mean? The best example is perhaps the earth. As we know, the earth rotates to the East. Given that the earth is round, it makes sense that the speed of the earth at the equator (the widest part) must move faster than at the poles. It must, since a person at the equator reaches the same point in space as the person at the pole.

That means that if an object were to be launched from a point on the equator North toward a target perhaps in Greenland, the object would miss its target unless it was corrected for Coriolis Effect. In other words, the object, when launched would be traveling at the same speed as the equator. As the object neared Greenland, it would encounter that part of the earth traveling much slower than at the equator. The net effect is that the object would appear to be moving to the East at a rapid rate when it is truly traveling in a straight line. The faster the object travels to Greenland, the more pronounced the effect.

Now imagine a tiny cylinder – a piezo element. On that cylinder are mounted electrodes. Some electrodes are used to apply electrical current and some are used to measure electrical current. When electrical current is applied, the piezo element bends to a predetermined shape. Now a frequency is applied to that current and the element begins to vibrate. Along the axis of this cylinder are the electrodes used to measure current. When the piezo is rotated about the longitudinal axis, there will be a secondary vibration caused by the Coriolis Effect. The electrodes receive this secondary vibration and translate that to mean rotational movement.

The reason that the piezo element vibrates is to create the speed necessary to produce the Coriolis Effect. Its vibrating motion is similar to the earth's rotation. The rotation of the vibrating piezo element causes the vibrations to go out of sync and these out of sync vibrations are what the gyro's electronics utilize to sense motion. Hopefully this bit of explanation helps you understand and appreciate the electronics of your Draganflyer even more. Imagine all this is going on while you're out just having a good time with your Draganflyer!

Flight Preparation and Trimming

Never fly this aircraft where damage to property or injury to persons may result if loss of control occurs.

Never leave the Draganflyer V Ti unattended with the battery connected to it.

Always disconnect the battery when not flying.

Always turn the Draganflyer V Ti off BEFORE turning off the transmitter. Failure to do so could cause the Draganflyer V Ti to become airborne and out of control resulting in injury or damage. We cannot stress this enough!

There are a few techniques and concepts you must understand if you want the Draganflyer V Ti to be an expression of your piloting skills. **Read this section thoroughly before attempting to fly!**

Ground Effect:

The Draganflyer V Ti, like any aircraft, is greatly affected by close proximity to the ground. Air from the rotors forms an air cushion below the Draganflyer and drastically changes its flight characteristics. This also creates that cushion of air which the Draganflyer V Ti can float on with less power. Do not expect to be able to hover when only about one inch above the ground. This altitude is only useful for safely learning what each control movement does. To learn to hover, the Draganflyer should be about eight inches above the ground. It is not until an altitude of about two feet that the Draganflyer is free of ground effect.

Rotor Blade Adjustment: Before each flight be sure to check and adjust the alignment of the rotor blades. The rotors must be adjusted so that they are horizontal in relation to the rest of the Draganflyer V Ti. The easiest way to do this is to look across the flat center section of the rotor and adjust the motor mount by twisting it until the rotor is aligned with the horizontal part of the main circuit board. Repeat this procedure for each rotor. Proper alignment of the rotor blades will alleviate excess trim requirements as well as make the Draganflyer V Ti much more stable and efficient, increasing both your enjoyment and flight times!

Trim: Besides the two sticks, there are four more vital controls on your radio transmitter. These are the trim tabs, and are located below and to the center of each stick. The throttle trim should be set in the center position. The trim tab below the throttle stick controls yaw (rotation about the center point), the trim tab to the left of the right stick is for pitch (tilting forwards and backwards), and the trim tab below the right stick controls roll (tilting to the left and right). The trim tabs, like the gyros, cannot make the Draganflyer perfectly stable. The trim tabs allow you to alleviate persistent and constant deviation from stable flight. These techniques will help you learn and bring confident, capable flight into the palms of your hands.

Wind: The Draganflyer V Ti can fly outdoors in a limited amount of wind, however, due to the very light disk loading of the Draganflyer V Ti, it will become difficult to remain stationary in a moderate breeze.

Ceiling: You can fly the Draganflyer V Ti as high as you like so long as you can still see it well enough to control it. However, care should be taken not to stay up too long as you may not have enough battery power to make a successful landing. Also, a rapid vertical descent should be avoided as you may not have enough power to recover.

Flight Preparation and Trimming continued

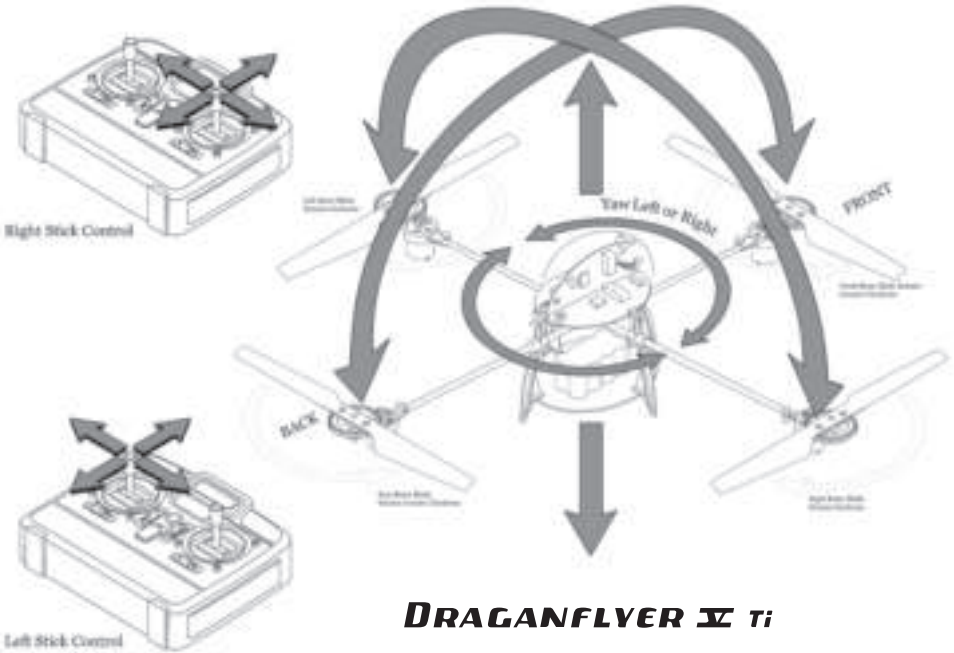

Flying With A Tether Cord

When learning to fly the Draganflyer V Ti, the key to successful flying is getting in the stick time (practice). This is best accomplished using the optional tether cord. The tether cord takes the place of the onboard battery pack. Simply remove the onboard battery pack, plug the tether cord into the circuit board, attach it to a power source and you will have flight times well beyond your expectations. We recommend limiting the flights to 10 minutes so the motors can have a chance to cool down and you can give your thumbs and brain a rest.

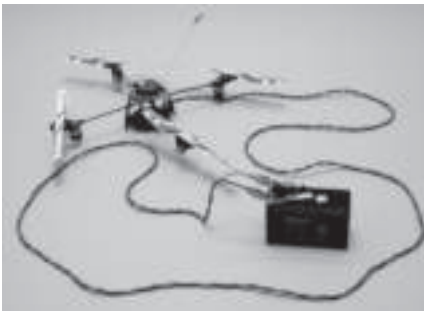

Flight Preparation and Trimming continued

Discharged Battery:

The Draganflyer V Ti is designed to hover at approximately 1/2 throttle with the supplied battery pack in the fully charged state. As the battery approaches the end of its charge, you will notice that almost maximum throttle position is required to maintain a hover. This is one way you can tell if the battery is running low, and it is at this point that you should begin your landing.

The Draganflyer V Ti also has a safety feature to prevent the battery from being discharged too far. When the battery voltage begins to drop the helicopter enters a forced landing condition. All of the controls will be the same except the maximum allowable throttle will be slowly reduced. In this mode all of the led 'eyes' will blink together. Land and recharge the battery. **Attempting to fly past this past this point will permanently damage the battery.**

Flight Time:

The Draganflyer V Ti should be able to hover for approx. 13-17 minutes on a fully charged battery pack. After that time, it will descend to a point where it will fly approx. a foot off the ground. After 10 to 20 seconds, you will notice that it takes more than 3/4 throttle to maintain a low hover. At this point the Draganflyer V Ti will start to become somewhat unstable and it is best to land and recharge the battery. This period of instability at the end of the battery charge is normal and is caused by the lower battery voltage in the discharged state.

Maintenance

Unlike a traditional helicopter, the Draganflyer V Ti requires very little maintenance, however there are some simple tasks which must be performed on a regular basis. Prior to each flight, you should check the following:

- Ensure the rotor screws have not loosened.
- Check the alignment of the rotors by aligning their flat center section with the horizontal part of the circuit board (this step is especially important after a crash)
- Check the rotor blades for chips and cracks. Small chips on the leading edge can be smoothed out using 150 grit sandpaper. Cracked rotor blades should be replaced immediately to avoid in-flight failure.
- Regularly clean thermal intelligence sensors with alcohol and soft cloth.
- Inspect the helicopter frame for cracks in the nylon components or carbon-fiber tubes. Twist each motor mount from side to side. If the mount is cracked, the nylon will separate (typically where the mount clamps to the carbon-fiber tube). If you are able to easily twist the mount assembly 90 degrees from vertical and the assembly has a 'spongy' feel to it, it is very likely you have a cracked carbon-fiber tube. In this case the tube **must** be replaced prior to the next flight.
- Extend the transmitter antenna fully and inspect it for serious bends or cracks in the antenna.
- Check the circuit board to ensure it is firmly retained in the vertical risers.
- As well, on a regular basis (every 1-3 hours of flight time) you should perform the following additional tasks:
 - Re-tighten all of the allen-head bolts in the frame (Be careful not to overtighten!) as well as the screws retaining the motors in their mounts and the acorn nuts on the carbon-fiber base plate.
 - After many hours of flying the fuse on the circuit board may need to be replaced.



Flight Training

It is preferable to learn to fly on days when there is little to no wind. For your first flights, select an open area. The best flying site would be a smooth paved area which will allow the Draganflyer V Ti to easily skid around on the ground. After mastering basic hovering, get away from the concrete and complete your training over long grass, as grass will be much more forgiving than concrete in the event of an uncontrolled landing or crash. Before you attempt to fly the Draganflyer V Ti for the first time, please make sure that the transmitter and flight battery are both fully charged and that you have read this manual thoroughly, are familiar with the terms we will use (pitch, roll, yaw, etc.), and are familiar with the controls.

Place the Draganflyer V Ti on a smooth surface (ie flat driveway, patio, etc.). Prepare the Draganflyer V Ti for flight using the pre-flight checklist found in the Flight Preparation Section. It is recommended that Ti is turned off for flight training.

Stand 10-20 feet away from the Draganflyer V Ti while you are learning how to fly.

Lesson 1: Directional Control

You are now ready to begin your first lesson on the Draganflyer V Ti. If at any point you become uncomfortable with the attitude or position of the Draganflyer V Ti, do not be afraid to turn off the throttle; it is better to have it fall than fly off uncontrolled. Remember, the Draganflyer V Ti is extremely durable.

Slowly increase the throttle until the Draganflyer V Ti just starts to get light. Do not increase the throttle any further at this point. Move the pitch (right stick, up/down motion), roll (right stick, left/right motion), and yaw (left stick, left/right motion) controls to verify their correct function. Adjust the trims until the Draganflyer V Ti no longer wants to wander off in any direction. If the Draganflyer V Ti has a severe tendency to veer off or tries to flip over, disconnect the battery and inspect the Draganflyer V Ti to ensure the rotor blades are correctly installed and aligned (see Assembly and Flight Trimming sections for more information).

Start practicing by keeping the front arm always pointing forward. Now, Gently push the pitch control forwards to start the Draganflyer V Ti slowly moving forwards and practice using the yaw control to control the direction of movement. Pull the pitch control backwards to bring the helicopter back towards yourself. At this point, keep the front (unique color rotor) of the Draganflyer V Ti facing away from yourself at all times. The trickiest part is getting used to the rotation. Practice skidding around on the ground until you are comfortable steering using the yaw, pitch, and roll controls. Remember to take a break every 5-10 minutes to both allow the Draganflyer V Ti battery and motors to cool down and to give your thumbs (and brain!) a rest.

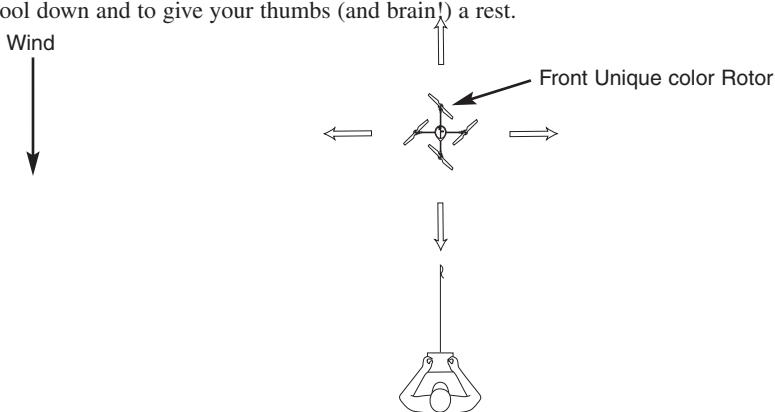

Flight Training continued

Lesson 2: Basic hovering

In this lesson, we will lift the Draganflyer V Ti off of the ground a small distance and practice hovering. Stay less than 1 foot above the ground. Remember that if you get into trouble, reduce the throttle to minimum immediately to lessen the chance of crashing the Draganflyer V Ti. Prepare the Draganflyer V Ti using the checklist we used in Lesson 1. Trimming the Draganflyer V Ti so that it does not wander off on it's own will make learning to hover much easier, so trim it out using the same procedure we also used in Lesson 1.

Reduce the throttle position to minimum once you have the trims set. Standing 15-20 feet away from the Draganflyer V Ti, slowly increase the throttle until it begins to lift off. Use the pitch controls to control the front/back movement, the roll controls to control the left/right movement, and the yaw controls to keep the front of the helicopter pointed away from yourself. Use gentle, smooth control inputs to avoid overcontrolling. At this point, do not worry about maintaining a perfect hover, just concentrate on keeping the Draganflyer V Ti level and within an imaginary 10 foot by 10 foot square.

Again, remember to take a break every 5-10 minutes to allow the Draganflyer V Ti battery and motors to cool down and to give your thumbs a rest. Once you are capable of maintaining a hover for 1-2 minutes and are comfortable, you can increase the throttle to allow the Draganflyer V Ti to climb up to waist or stomach height(For safety reasons, you should never fly at or near eye level). At this altitude, control will actually be easier, and you can practice tightening up that imaginary square until you can maintain a steady hover. To descend for landing, decrease the throttle a small amount(2-3 "clicks" on the throttle stick) and allow the Draganflyer V Ti to gently settle to the ground. Keep practicing hovering as it is a requirement before being able to take off and land, as well as perform many other maneuvers. Most people will take 1-2 hours of practice to be able to hover steadily, so don't get discouraged if you do not pick up the skill immediately.

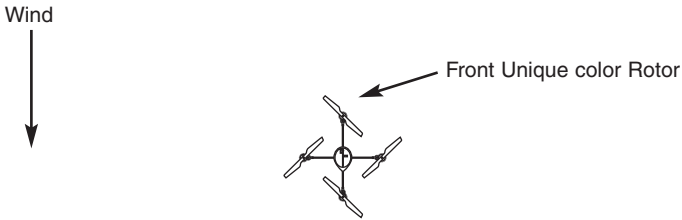

Keep the Draganflyer V Ti less than one foot off the ground until you can maintain the hover for one - two minutes.

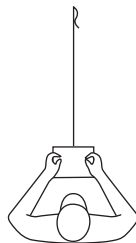

Flight Training continued

Lesson 3: Movements

This time, we will learn to move the Draganflyer V Ti around in a hover. This will teach you how to transition from a hover to moving flight and back again. Prepare the Draganflyer V Ti using the same checklist and trimming technique we have used in previous lessons. For this lesson you should also select a location where you can take off and land on a smooth surface and fly over a grassy area. The edge of your driveway or patio would be well suited for this if the area is free of obstructions. If you are comfortable enough, you can begin this lesson by taking off closer to yourself (5 feet would be a minimum safe distance). This will allow you to keep the Draganflyer V Ti over the grassy area for the duration of the flight.

Lift 2-3 feet off the ground and gently push forward on the pitch control momentarily to move a safe distance away from yourself. Return the pitch control to neutral once forward movement has begun. Pull back gently to cause the Draganflyer V Ti to decelerate and then attempt to establish a hover at the waist/stomach level. If you choose to land in the grass ensure that the throttle is reduced to the lowest possible setting once on the ground to avoid stalling a motor. Takeoffs from grass are not recommended as the blades of grass can be hard on the rotors and drive train.

Now, imagine a large square drawn on the ground in front of you.

Using very gentle movements at first, and keeping the front away from yourself at all times, try to fly from one corner of the square to another along the edges. Allow a slight delay after your control input for the Draganflyer V Ti to accelerate/decelerate. A small increase in throttle may be required to maintain altitude as you are applying pitch/roll inputs. It is better to lose a small amount of altitude than to apply too much throttle and have the Draganflyer V Ti climb out of your control, so be gentle on the throttle.

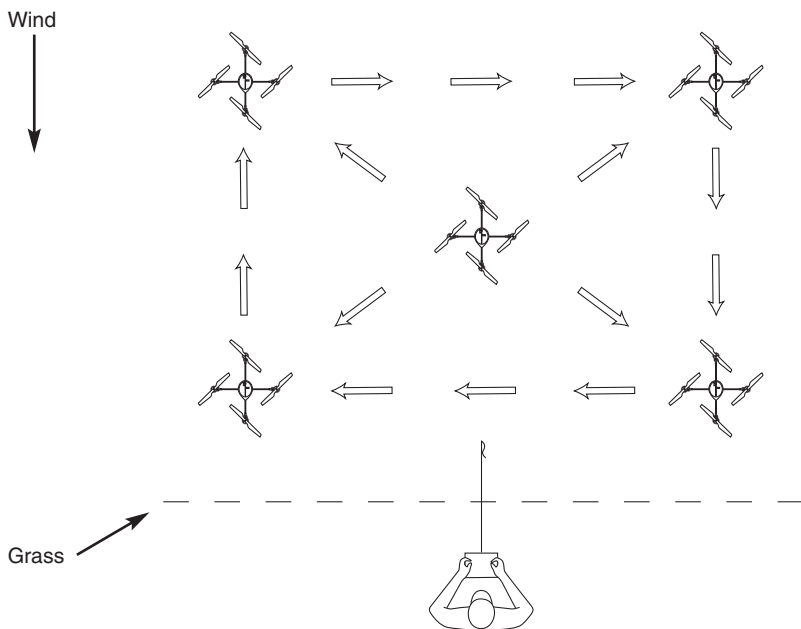

Flight Training continued

What you put in, by way of control, you will have to take out. If you roll to the right, make sure you roll a bit back to the left or the Draganflyer V Ti will just keep going in the last direction it was told to. Use appropriate pitch/roll control inputs to decelerate as you approach the corners of the imaginary square. Once you are comfortable flying forward, backward, left, or right, try combining the pitch and roll to fly diagonally across the imaginary square. As you practice, slowly start adding more control inputs to increase the speed of the movements until you can fly around that imaginary square at a comfortable walking pace. As always, remember to take a break every 5-10 minutes.

Lesson 4: Orientation

The object of this lesson will be to teach you to control the Draganflyer V Ti in orientations other than “nose-out”. Start by again going through the checklist and trimming procedures previously used and selecting an area where you will be able to take off from a smooth area and fly over grass. Keep the Draganflyer V Ti fairly low to the ground as it is likely that you will lose the hover at at least one time during this lesson.

Start by using the yaw control to slowly rotate the Draganflyer V Ti from left to right and back again (do not rotate further than 10-15 degrees initially) around its vertical axis. Once you are comfortable yawing the Draganflyer V Ti, start rotating further until you have spun it 90 degrees from the starting position. It will help to turn so you are facing in the same direction as the front of the Draganflyer V Ti and watch it over your shoulder. Practice turning your body less until you are comfortable hovering with the left or right rotors directly in front of you. Remember to take a break every 5-10 minutes.

Once you master hovering the Draganflyer V Ti with it turned 90 degrees to yourself, you can think about beginning to practice nose- in flight. To do this, you will be best served to repeat lessons 1, 2, and 3, but complete all these with the front of the Draganflyer V Ti turned towards yourself. The roll and pitch controls will be reversed in this orientation, so don't rush! Learning to fly “nose-in” will be just like learning to fly all over again, but don't get discouraged! Try to practice a few minutes of nose-in each time you fly the Draganflyer V Ti, and continue through the rest of the flying lessons.

Front Unique color Rotor

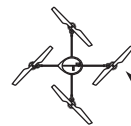
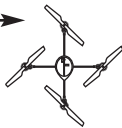

Front Unique color Rotor

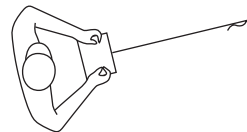
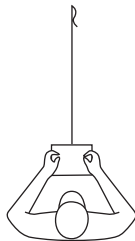

Flight Training continued

Lesson 5: Climbs and Descents

Now you are ready to begin flying the Draganflyer V Ti at higher altitudes. The helicopter does not know it has gone any higher, so the only real factor here your own nerves. Climbing is easy; just add power and it will smoothly climb out. Reduce the throttle setting to hover, and the climb will stop naturally.(Remember, small movements are key) Descending is more difficult. Because the Draganflyer V Ti forces air downwards to generate the lift it needs to fly(this is called downwash), as you descend vertically, you will pass into air that is moving downwards, causing the helicopter to accelerate as it descends. To counter this, you can either begin the descent and then add small amounts of power as necessary to offset the downwards acceleration, or you can descend while moving the Draganflyer V Ti forwards, backwards, left, or right. Descending in this manner will allow you to fly outside of the downwash the helicopter generates. Set up for this lesson by first making sure your batteries are fully charged(because you will now be flying higher above the ground, the risk is greater if the batteries die unexpectedly), then prepare the Draganflyer V Ti for flight and trim it out as you have done in previous lessons. Stand well away, as you will be passing through your eye level, and make sure any spectators are also a safe distance away. Start by establishing a hover, then add power to climb to just above your head. Reduce power to stop the climb, settle back into a hover, then slowly descend. Keep the front of the Draganflyer V Ti away from yourself at all times. Repeat this process until you can climb and descend comfortably. Now you can begin climbing higher and faster, however keep in mind that the higher you fly, the greater the risk of causing damage in a crash. As well, you should keep the remaining power in the battery in mind, as you will be drawing more power from the flight battery by climbing repeatedly.



CONGRATULATIONS. You have now learned to fly the Draganflyer V Ti. The abilities to transition from a hover to a climb or sideways movement while maintaining directional control are the essential skills needed to fly. You should now be able to take off, land, and fly around at will. Keep practicing, you will soon be flying just like the professional pilots in our videos!

Advanced Flight Training

There are two additional lessons that will teach you to control the Draganflyer V Ti while in forward flight. These are advanced topics, and you should be very comfortable with flying around rapidly, climbing, and descending before you attempt these.

Lesson 6: Introduction to Forward Flight

Forward flight is classified as anytime the Draganflyer V Ti is moving horizontally through the air; this could be forwards, backwards, left or right. This is an advanced topic, so this lesson will be fairly brief.

Select a large, open area, away from anything or anybody that the Draganflyer V Ti might cause damage to. Prepare for flight and trim the helicopter. Begin by establishing a hover just above your head and at least 25-30 feet away from yourself. Turn 90 degrees and start moving forwards. Continue the forward motion, and turn to begin flying in a circle around yourself. Do not fly around yourself continuously as you may get dizzy, instead fly a few circles to the left, then to the right, taking breaks often. Try to maintain a constant altitude and to keep the front of the Draganflyer V Ti continuously pointed in the direction of motion. Once you can fly circles around yourself, try reversing direction as you complete each circle and climbing/descending as you fly.

Lesson 7: Advanced Forward Flight

If you have mastered basic forward flight and nose-in flight, you are truly a master of the Draganflyer V Ti. Flying figure-8s will be the last test. Once you can fly the figure-8 consistently and repeatedly, you are ready to perform any other advanced maneuvers such as pirouettes, fast forward(and backward!) flight, rapid climbs and descents, and anything else you can think of.

Please remember however, to keep safety first. It's no fun when somebody gets hurt.

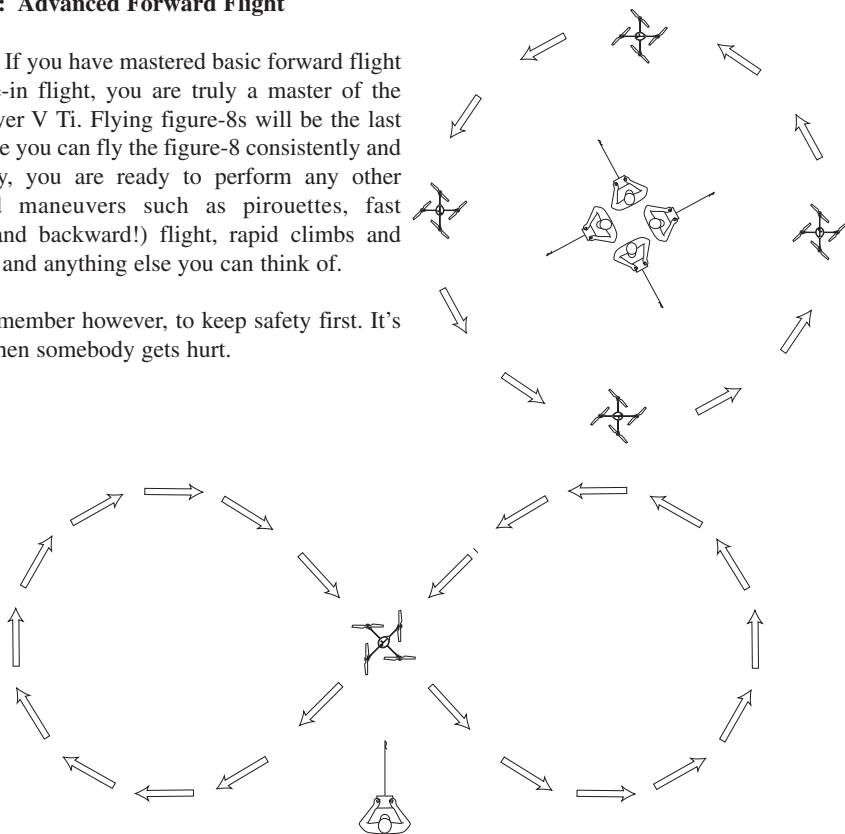

Optional Eyecam Wireless Video

Every Draganflyer purchased with the Eyecam or Eyecam Extreme has a fully adjustable camera mount pre-installed on the circuit board. The camera is held in by a rubber 'o' ring that needs to be stretched over the camera and attached to the hooks on the mount. We suggest using the supplied allen key for this. Although the camera mount is installed, all the screws have to be tightened with the supplied allen key once you achieve the desired angle.

The Eyecam system comes with a receiver. This receiver can be plugged into a TV to watch your flight in real-time, or a VCR or digital video camera to record the footage. The antenna in the receiver is located opposite to the jacks, and this end should be pointing to the Draganflyer. If you are interested in more information regarding the Draganflyer/EyeCam setup, many independent reviews have been completed. Links are available on our website at <http://www.rctoys.com>

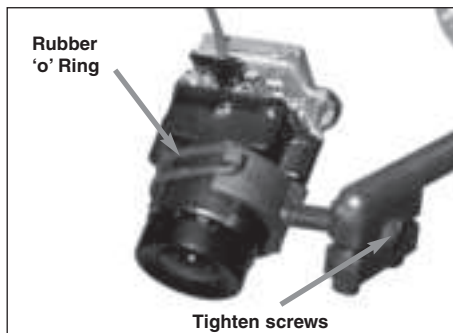

It used to be that only the military and TV stations that could afford to use airborne video equipment, but now thanks to advances in technology everyone can put an "eye in the sky." Neighborhood watch has really taken-off with the Draganflyer V Ti. Check out our website at <http://www.rctoys.com> to see some of the fun you can have with a camera equipped Draganflyer V Ti.

When you shoot video with the Draganflyer V Ti remember the range of the video camera transmitter is limited to about 750-1000 feet, but you should not be that far apart because the signal strength decreases with distance. Metal objects and other transmitters or noisy electrical circuits and motors may also interfere with the signal. The receiver works best if it is above the ground as much as possible and in direct line of sight with the transmitter. Some break-up and noise is inevitable; you will not get perfect footage. Do not forget that even multi-million dollar communications systems are subject to interference.

Things you should know about Eyecam

- **EYECAM TRANSMITTER SENDS VIDEO ONLY – IT HAS NO AUDIO TRANSMISSION CAPABILITY**
- Best Results are achieved where there is a clear “line of sight” between the Eyecam transmitter and Receiver
- Try to avoid obstacles such as trees, walls, cars, trucks, and buildings.
- Transmitting over water and in rain will reduce performance.
- Interference from certain electronic equipment or the moving human body can also affect the range obtainable.
- For best reception, position the antennas of the transmitter and receiver 1.5 to 2m above the ground. Please test all devices before final installation because transmission quality can often be improved by moving the components slightly.
- Turn off the transmitter and receiver if the system is not in use.
- Do not touch the antennas when the system is switched on.
- Do not place the receiver behind a monitor or TV.

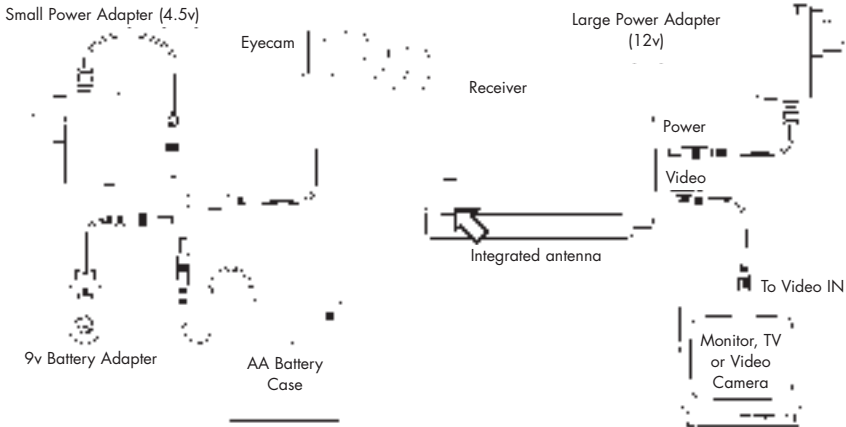

Tips for Shooting Eyecam Video

When we shot our videos we had a pilot flying and a director/helper aiming the receiver and coaching the pilot about which shots from the Draganflyer V Ti looked the best. The lens on the video camera has a fixed focal length, which means if you want a close up of an object you have to fly close to it or move back for a wide shot. The director/helper can be most useful by telling the pilot if the target is in the shot and what to do to make the shot better. After awhile the pilot can get a feel for positioning the Draganflyer V Ti for a shot but it takes practice. The camcorder we used had an LCD screen so we were able to do the establishing shots of the Draganflyer V Ti from the pilot's point of view and then connect the video receiver from the onboard camera to the camcorder without using a separate monitor. This arrangement is convenient and mobile.

Don't try to get all your shots on one flight. Better to get one good shot per flight than lots of crummy ones. Radical moves look good from the observer's perspective but from the onboard camera they mostly make the audience want to reach for a barf bag! Save the killer moves for when they will impress Mr. Lucas and Mr. Spielberg!!!

Troubleshooting the Eyecam

Poor Picture: Realign antennas, slightly adjust the position of the Eyecam or Receiver. Reduce or increase the distance between Eyecam or Receiver.

Line only - no picture: Check to confirm there is no microwave oven or other 2.4GHz equipment operating close by.

Picture ghosting: Check for interference caused by obstacles such as trees, buildings and shrubs etc. Try a different location for the Eyecam/Receiver.

No picture: check the receiver to confirm it is turned ON and make sure the A/V connection of the Receiver is not plugged the wrong way around.

Eyecam Warnings

To avoid the risk of damage to Eyecam, use only the supplied power supply.

Don't place above or near a heat source which may cause the equipment to overheat.

Avoid "Oily" locations.

Microwave ovens can cause interference and diminish the quality of the signal if the Eyecam or Receiver are located close by.

Beware of humid locations. Water droplets or spray may damage the units. If condensation does occur, do not use until the equipment has dried out.

Do not use in temperatures exceeding 55°C.

Never paint or attach metallic labels or stickers of any kind.

Do not cut the DC power cable of the Eyecam to fit with another power source. This may result in damage to the Eyecam and will void warranty.

Eyecam Technical Specifications

2.4 GHz color video miniature camera:

Frequency: 2.4GHz frequency band, one channel

RF output power: 10mW

Operating power: 5-7V

Power consumption: 80mA

Size: 15 x 24 x 20 mm

Antenna: omni-directional antenna

Transmitting range: 300M(L-O-S)

Weight: 9 grams

Pixels: 365K(PAL), 250(NTSC)

Resolution: horizontal 380 TV Lines

Auto electronic exposure: 1/60 - 1/15000sec

Automatic exposure/gain/white balance

Pin hole f=3.6mm/angle view:92°

Power supply: 5 - 7 V



Receiver:

Frequency: 2.4Ghz frequency band

Video input/output: 1Vp - p/75ohms

Operating power: 12V

Power consumption: 180mA

Troubleshooting

PROBLEM	CAUSE / SOLUTION
One or more motors is not working	<ul style="list-style-type: none"> • Ensure that the main wire harness is securely and correctly plugged into the circuit board. • Charge Draganflyer V Ti battery pack fully. • Broken wire or defective motor. Inspect wires coming from center section and exiting at motor mounts. Replace harness. • Damaged circuit board. Call technical support for assistance.
No response from the Draganflyer V Ti	<ul style="list-style-type: none"> • Charge Draganflyer V Ti battery pack fully • Check battery pack connection • Ensure that the main wire harness is securely plugged into the circuit board. • Charge transmitter battery pack fully. • Ensure that the transmitter throttle stick is in the low position before attempting to arm. • Make sure antenna is properly connected
Low flight times	<ul style="list-style-type: none"> • Make sure that the blades have not deformed. • Charge Draganflyer V Ti battery pack fully. • Motors may be worn out. Replace with new motors. • Motors have overheated. Allow them to cool. • Ensure the main black gear is not too tight. Loosen bolt until the gear spins freely. • Ensure rotors are properly aligned.
Motor shakes violently	<ul style="list-style-type: none"> • Check carbon fiber tube for torsional strength. • Check for rotor blade damage. • Check for broken motor mount. • Loose rotor mounting screw.
Draganflyer V Ti has no lift	<ul style="list-style-type: none"> • Make sure that the blades are mounted on the correct motors. • Ensure that the rotors have been properly shaped. • Low battery voltage. Charge battery pack fully. • Motor's worn out. • Magnet in motor dropped.
The rotors are spinning at different RPMs(it is normal for the rotors to turn at different RPM until approximately 1/3-1/2 throttle)	<ul style="list-style-type: none"> • Ensure the Draganflyer V Ti is placed on a flat surface. • Check that the rotors have not deformed. • Check trim positions. • Ensure the main black gear is not too tight. Loosen bolt until the gear spins freely.
Draganflyer V Ti wobbles during flight	<ul style="list-style-type: none"> • Check for a broken rotor. Replace with new rotor if necessary. • Battery low. Recharge battery pack. • Check carbon fiber tubes for cracks. • Check for broken motor mount. • Circuit board is loose in mountings. • A slight wobble when using a freshly charged battery is normal and will diminish as battery is discharged in flight.

Troubleshooting continued

PROBLEM	CAUSE / SOLUTION
Rotor does not turn or is slower than others	<ul style="list-style-type: none"> • Check pinions on motors. If they have come loose reattach using Red Loctite (tm). • Main black gear is too tight. Loosen bolt until gear spins freely • Broken wire or defective motor
Draganflyer V Ti acts erratically	<ul style="list-style-type: none"> • Low transmitter battery. Recharge transmitter fully. • Motor capacitor may be defective or grounding out • Main circuit board may have moisture or condensation. Allow to dry indoors for 24 hours or use a hair dryer on low setting • Antenna on Draganflyer V Ti may be loose. Retighten gently. • Circuit board may be loose in mountings. • Circuit board is installed incorrectly. Install circuit board with green lights aligned with red dot on frame.
The Draganflyer V Ti starts normally but suddenly stops or disarms.	<ul style="list-style-type: none"> • Low Draganflyer V Ti battery pack voltage. Charge the battery pack fully. • Be sure that the motor capacitor is not grounded on the motor shell or cracked from a crash. • Damaged circuit board. Call technical support for assistance.
Flight controls are reversed	<ul style="list-style-type: none"> • You are attempting to fly “nose-in” without proper training. Fly with unique color rotor(front) facing away from you. • Transmitter reversing switches have been altered. Call technical support for assistance in correctly setting reversing switches.
Draganflyer V Ti will not hover without constant control inputs	<ul style="list-style-type: none"> • This is normal. Helicopters are naturally unstable and will require constant correction. Practice, practice, practice!
Wireless video is shaky or has vibration.	<ul style="list-style-type: none"> • Vibration is normal with any mechanical device. Balancing the rotor blades will help alleviate this. • It is very difficult to maintain a steady hover as seen from the Eyecam. Continue practicing to increase the stability of your hover.
Motors twist in flight	<ul style="list-style-type: none"> • Bolts retaining motor mounts on arms have loosened. Retighten, but be certain to overtighten so the mounts will rotate if impacted in a crash.
Heatsinks keep falling off of motors.	<ul style="list-style-type: none"> • Remove heatsink and bend slightly inwards to increase the friction fit between the heatsink and motor
Spouse does not like Draganflyer V Ti being flown in house.	<ul style="list-style-type: none"> • Replace husband/wife with newer, more understanding model.

Draganflyer V Ti Parts List

<u>Draganflyer V Ti parts list</u>	<u>Price (USD)</u>
Draganflyer Rotors (set of 4 with decal sheet)	28.95
Draganflyer Crash kit (rotor set, 2 motor mounts, 2 carbon tubes,1 canopy, 1 riser)	47.89
Draganflyer Motor mount	5.95
1 set of Draganflyer Heavy Duty Aluminum Heat Sinks	14.95
Replacement Draganflyer Carbon fiber rod.....	3.95
Draganflyer V Ti Canopy.....	14.95
Draganflyer 3-cell 11.1 volt 1300mAh Li-Poly battery with protection circuitry	69.95
Draganflyer 3-cell 11.1 volt 1900mAh Li-Poly battery with protection circuitry	99.95
Draganflyer 12ft Tether cord	24.95
Replacement Draganflyer frame (does not include motors,main gears, or bearings)	79.95
Draganflyer Main gear	7.95
Draganflyer Main gear bearing	4.95
Draganflyer Nylon rotor screw set (set of 8).....	2.95
Draganflyer Rotor Decal sheet.....	3.95
Draganflyer Vertical riser.....	5.95
Draganflyer Center cross piece	7.95
AC Digital Charger with Power Supply (charges 3 cells Lithium-Polymer and transmitter) .	69.95
Draganflyer Main wire harness	12.95
Draganflyer Carbon fiber base plate	14.95
Draganflyer Complete screw set (includes all screws)	9.95
Draganflyer Motor (capacitor and pinion gear factory installed)	12.95
Draganflyer Fully Articulating Eyecam mount	19.95
Replacement Draganflyer circuit board.....	399.95
Replacement Draganflyer circuit board antenna	2.95
Replacement Draganflyer circuit board power switch	5.95
Replacement 4 channel FM transmitter	89.95
Replacement 6 channel FM Transmitter	139.95
Eyecam 2.4GHz color video camera	249.95
Draganflyer Motor Capacitor (10nF, 100V)	0.50
10 amp fuse for Draganflyer V Ti circuit board	1.95
Rubber 'o' ring for Draganflyer Camera Mount.....	0.50
Draganfly Innovations ball cap	9.95
Draganfly Innovations frisbee	2.95
Draganfly Innovations T-shirt (S, M, L, XL).....	14.95

For detailed descriptions of all parts or to order these parts online please visit us at:

www.rctoys.com/parts

